

INSTRUCTION SHEET- F4D051

HINGED WALL-MOUNT BRACKET 3U

INSTRUCTIONS

1. Mark locations for two screws on your wall. They must be 16 inches apart horizontally, and level. Standard stud spacing in the wall is 16 inches (C).
2. Attach bracket to wall using the proper screws (A) (not provided).
3. Attach panel (B) to bracket with screws provided (2).

NOTE:

- The mounting holes on the bracket are spaced 16 inches apart to allow attachment to the wall studs.
- For best results, locate the wall studs and screw directly into them.
- If there are no studs available, make sure to use a high-strength anchor in wallboard.
- Never screw into wallboard without the proper anchor.
- Because of the many different types of walls, mounting screws are not included.
- For masonry walls, use a lag anchor and screw (at least #10).
- For drywall with studs, use a wood screw two inches in length t least #10).
- For drywall without stud mounting, use an auger anchor and screw (at least #10).

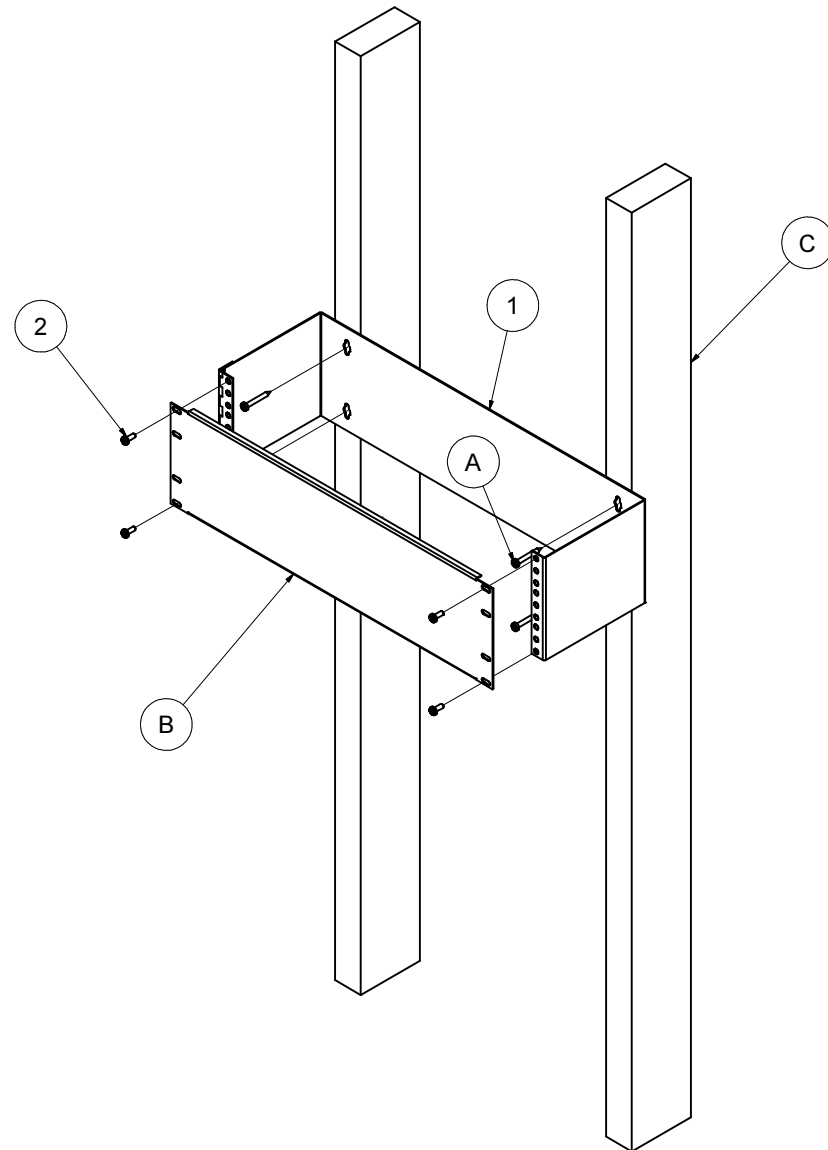

TOOLS NEEDED:

#2 Phillips screwdriver
Level

PARTS LIST

ITEM	QTY	DESCRIPTION
1	1	Wall-Mount Bracket
2	4	Pan Head phillips 10-32 x 0.5